



Thule XT Kit 3021

> Instructions

- DACIA Dokker**, 4-dr Van, 12-
- FIAT Doblo**, 3-dr Van, 00-03, 04-05, 06-09
- FIAT Doblo**, 4-dr Van, 00-03, 04-05, 06-09
- FIAT Doblo**, 5-dr Van, 00-03, 04-05, 06-09
- FIAT Doblo Maxi**, 4-dr Van, 08-09
- FORD Tourneo Connect**, 5-dr Bus, 03-13
- FORD Transit Connect**, 4-dr Van, 03-13
- MERCEDES Citan**, 4-dr Van, 12-
- NISSAN Kubistar**, 5-dr Van, 97-09
- RENAULT Kangoo**, 5-dr Van, 97-07, 08-
- RENAULT Kangoo Maxi**, 5-dr Van, 10-

This kit is only for vehicles with fixpoint mounting.

751 FootPack

753 FootPack

Security

6 kg / 13 lbs

Max. 75 kg / 165 lbs

9 kg / 20 lbs

Max. 100 kg / 220 lbs

80 km/h / 50 Mph

130 km/h / 80 Mph

40 km/h / 25 Mph

km/h / Mph

ISO 11154-E

183021

C.20151008
509-3021-07

Bring your life
thule.com

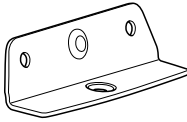

◀ **01** x4

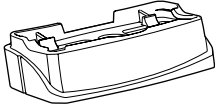

◀ **26** x2

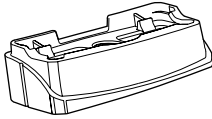

◀ **27** x2



751
FootPack

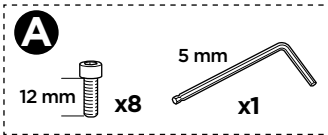

753
FootPack

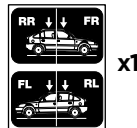
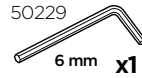
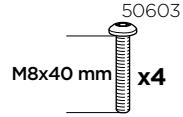
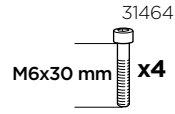
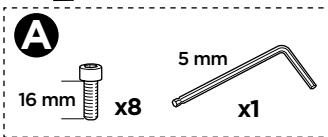

x1

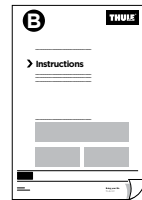

x1

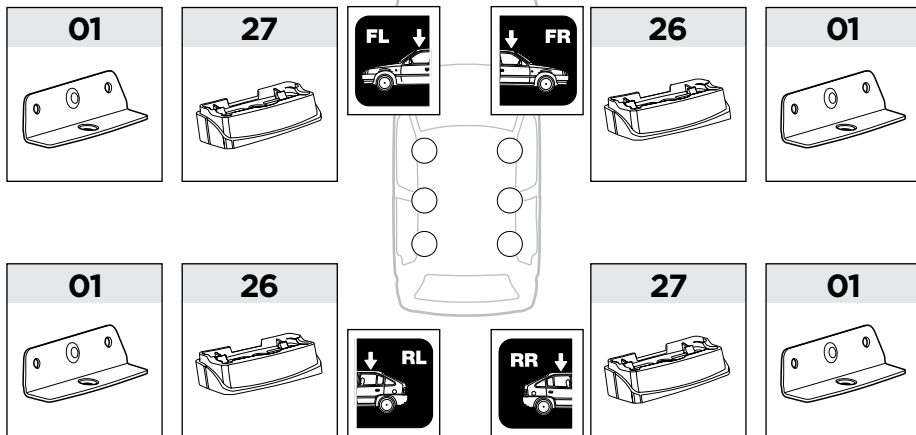
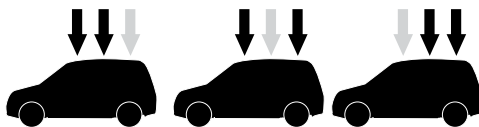
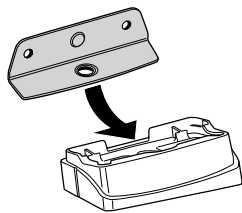
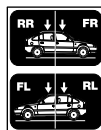
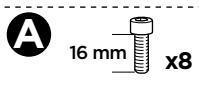
1**753**
FootPack**A****B**

x1

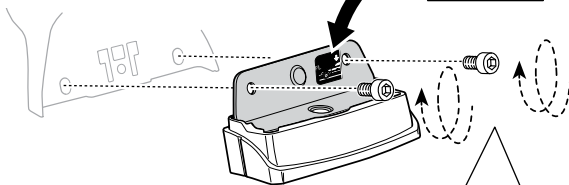
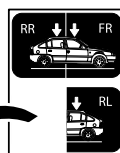

EN Only a few turns
DE Nur wenige Umdrehungen
FR Quelques tours uniquement
NL Slechts enkele slagen
IT Solo qualche giro
ES Sólo algunas vueltas
PT Noções básicas
SV Endast några varv
DK Kun nogle få omgange
NE Bare noen få omdreinger
FI Vain muutama kierros

ET Ainult mõni pööre
LV Tikai dažī apgriezieni
LT Tik keli pasukimai
PL Wystarczy kilka obrotów
RU Только несколько оборотов
UK Лише декілька обертів
BG Само няколко завъртания
CS Pouze několik otáček
SK Len niekoľko otáčok
SL Le nekaj obratov
HR/BIH Samo nekoliko okreta

RO Doar câteva rotiri
HU Csak néhány fordítás
EL Μόνο λίγες περιστροφές
TR Yalnızca birkaç tur

بعض دورات فقط **AR**
 רק מספר סיבובים **HE**

ZH 仅几圈
JA 2～3回転のみ
KO 몇 번만 돌리면 됨
TH เพียงสองสามรอบ

1



751 753 753

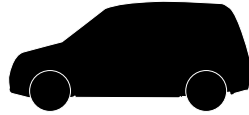

RENAULT Kangoo Maxi

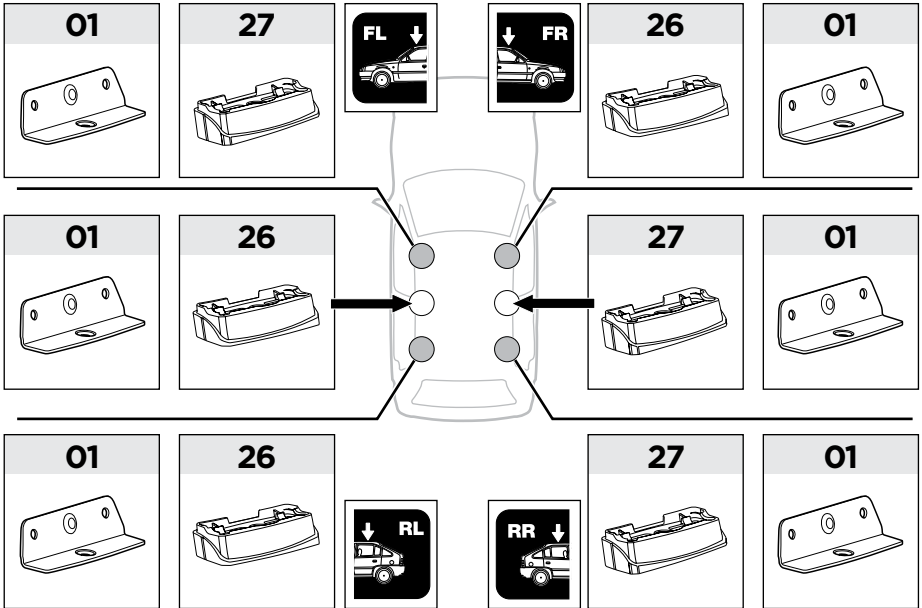

A

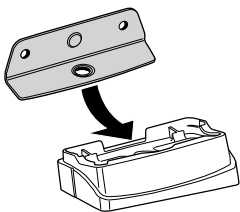

B

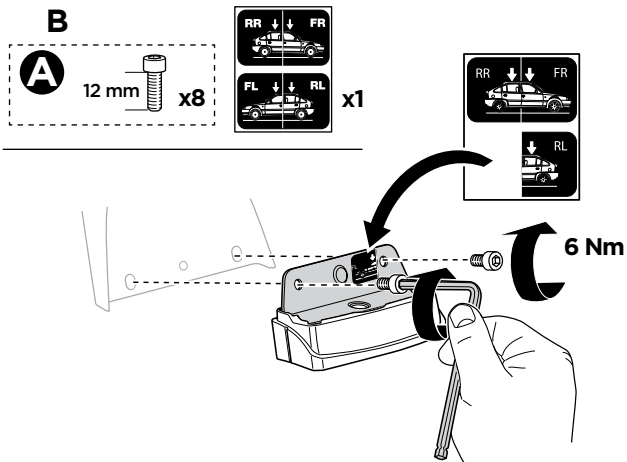

1

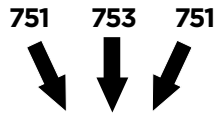

DACIA Dokker

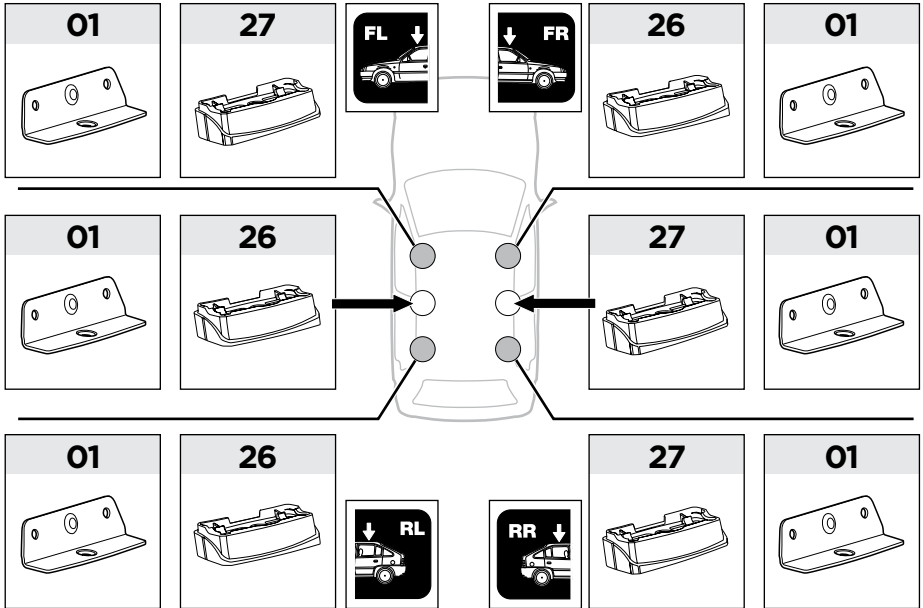

A

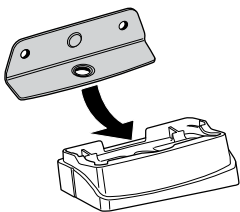

B

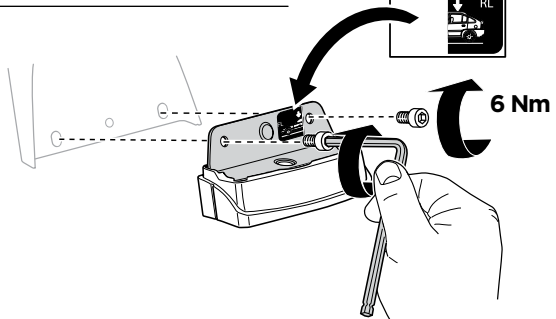
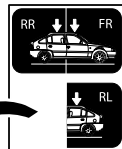
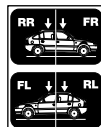
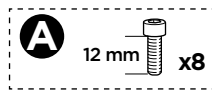

2 751 FootPack

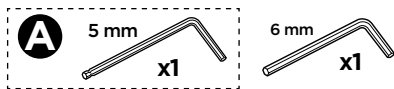

A DACIA Dokker RENAULT Kangoo Maxi

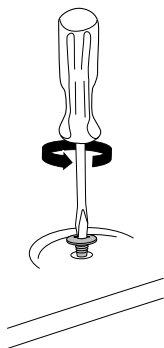

B

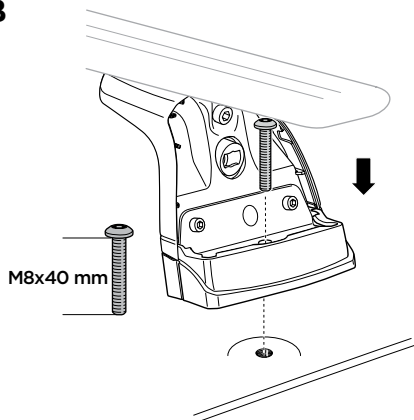

C

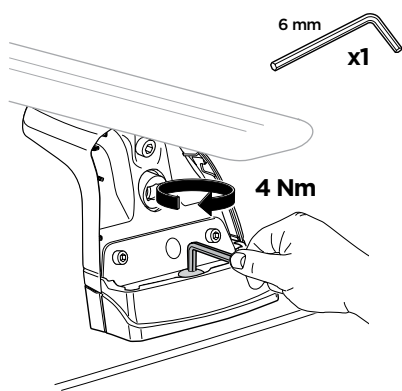

D

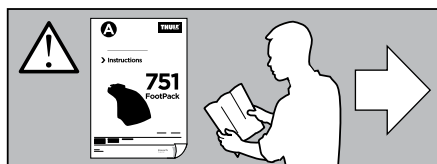
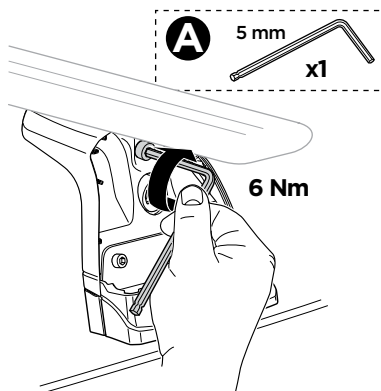

2

753 FootPack

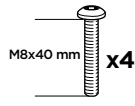
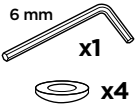
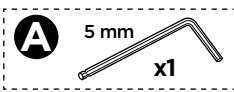
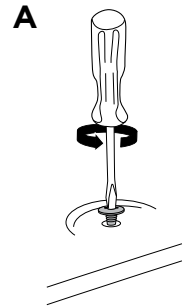
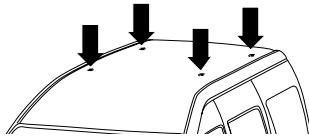

B FIAT Doblo,
FIAT Doblo Maxi

DACIA Dokker
FORD Tourneo Connect
FORD Transit Connect
MERCEDES Citan

NISSAN Kubistar
RENAULT Kangoo
RENAULT Kangoo Maxi

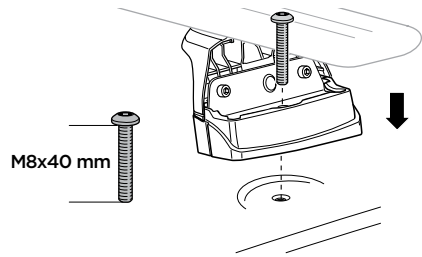
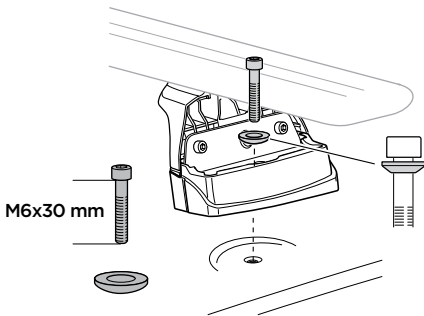

C FIAT

DACIA
FORD
MERCEDES
NISSAN
RENAULT

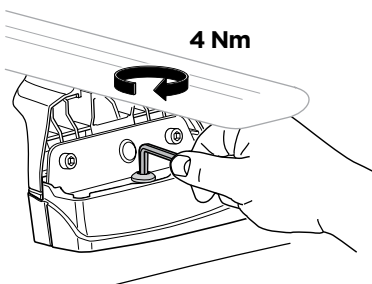
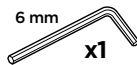
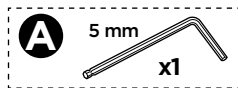

D

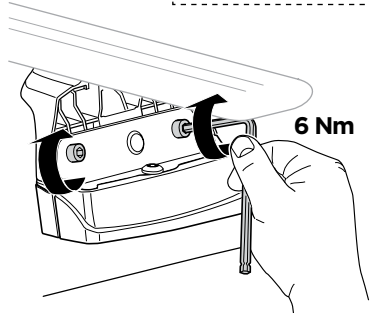
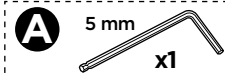

WW ▶
NA ▶



Thule Sweden AB, Box 69, 330 33 Hillerstorp, SWEDEN
Thule Inc., 42 Silvermine Road, Seymour, Connecticut 06483, USA

 info@thule.com

 Phone: 800-238-2388



www.thule.com