

# Thule Rapid System Kit 1682

# > Instructions

**CITROËN C-Zero**, 5-dr Hatchback, 10-

**MITSUBISHI i-MiEV**, 5-dr Hatchback, 10- / \*12-

\*North America

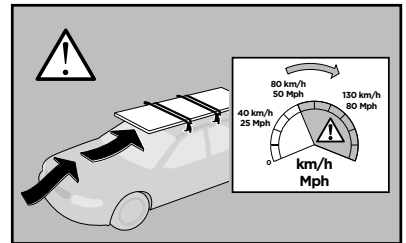
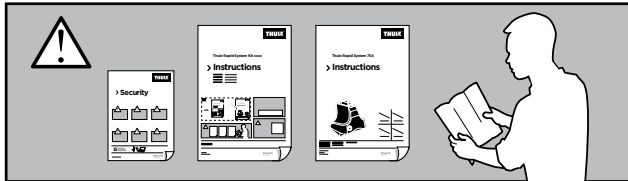
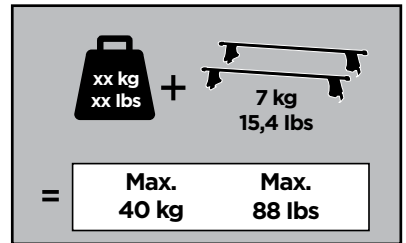
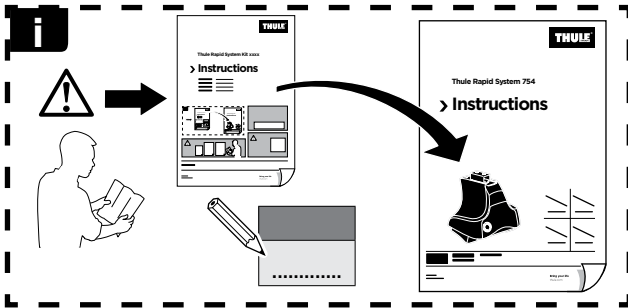

ISO 11154-E

141682

C.20120530  
519-1682-01

Bring your life

thule.com



178 x2

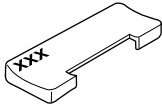

216 x2

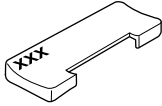

1188 x4



x1

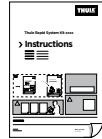

x1

1

	X (scale)	X (mm)	X (inch)
<b>CITROËN C-Zero</b> , 5-dr Hatchback, 10-	36,5	1016	40
<b>MITSUBISHI i-MIEV</b> , 5-dr Hatchback, 10- / *12-	36,5	1016	40

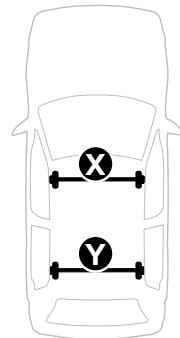
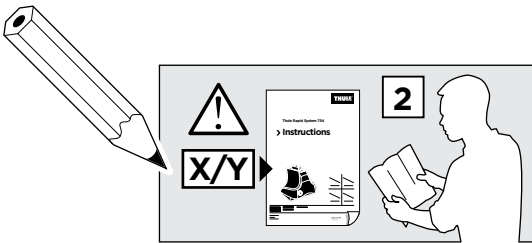

	Y (scale)	Y (mm)	Y (inch)
<b>CITROËN C-Zero</b> , 5-dr Hatchback, 10-	35	1001	39 <sup>3</sup> / <sub>8</sub>
<b>MITSUBISHI i-MIEV</b> , 5-dr Hatchback, 10- / *12-	35	1001	39 <sup>3</sup> / <sub>8</sub>

**2**

**CITROËN C-Zero**, 5-dr Hatchback, 10-  
**MITSUBISHI i-MIEV**, 5-dr Hatchback, 10- / \*12-

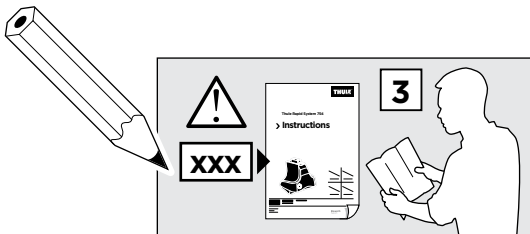
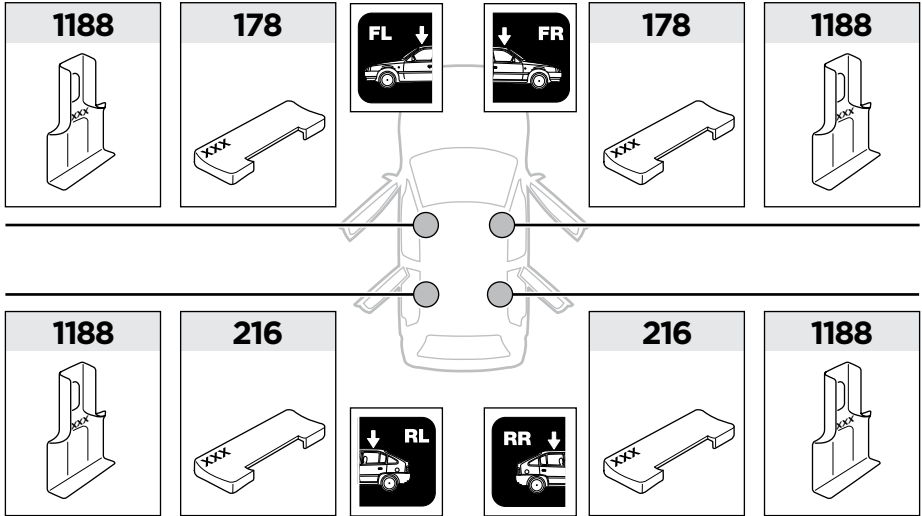

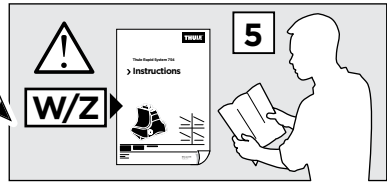
**3**

	W (mm)	Z (mm)	W (inch)	Z (inch)
<b>CITROËN C-Zero</b> , 5-dr Hatchback, 10-	<b>410</b>	<b>700</b>	<b>16 <sup>7</sup>/<sub>8</sub></b>	<b>27 <sup>1</sup>/<sub>2</sub></b>
<b>MITSUBISHI i-MiEV</b> , 5-dr Hatchback, 10- / *12-	<b>410</b>	<b>700</b>	<b>16 <sup>7</sup>/<sub>8</sub></b>	<b>27 <sup>1</sup>/<sub>2</sub></b>

