

Kit 1435

INFINITI I30, 4-dr Sedan, *95-99

NISSAN Maxima, 4-dr Sedan, 95-99

*North America

480R
754

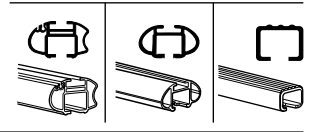
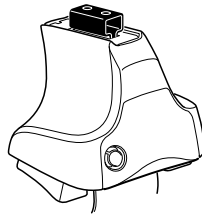

480

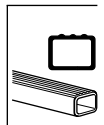
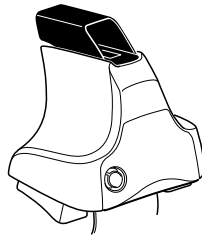

750

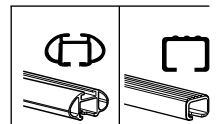
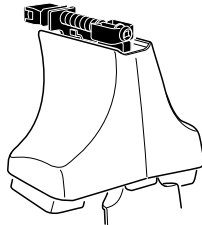

Kit



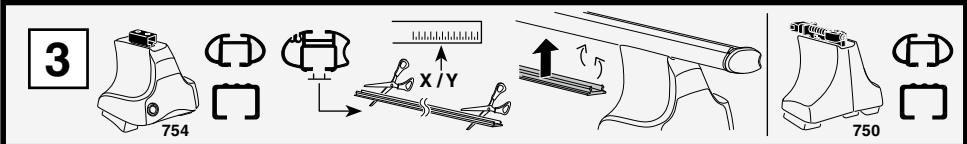

1

2

	X
INFINITI I30, 4-dr Sedan, *95-99	29
NISSAN Maxima, 4-dr Sedan, 95-99	29

1

2

	Y
INFINITI I30, 4-dr Sedan, *95-99	29
NISSAN Maxima, 4-dr Sedan, 95-99	29

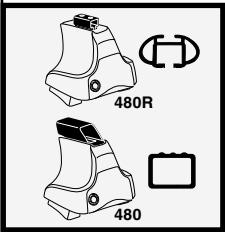

1

2

	X inch	X mm
INFINITI I30, 4-dr Sedan, *95-99	37"	941 mm
NISSAN Maxima, 4-dr Sedan, 95-99	37"	941 mm

1

2

	Y inch	Y mm
INFINITI I30, 4-dr Sedan, *95-99	37"	941 mm
NISSAN Maxima, 4-dr Sedan, 95-99	37"	941 mm

4

INFINITI I30, 4-dr Sedan, *95-99

NISSAN Maxima, 4-dr Sedan, 95-99

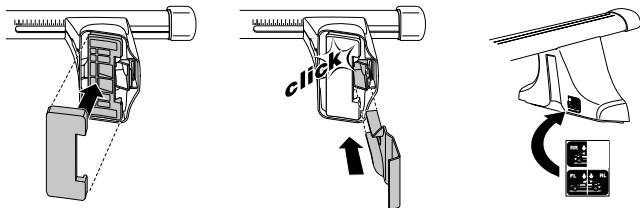
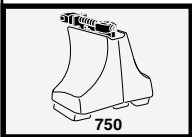
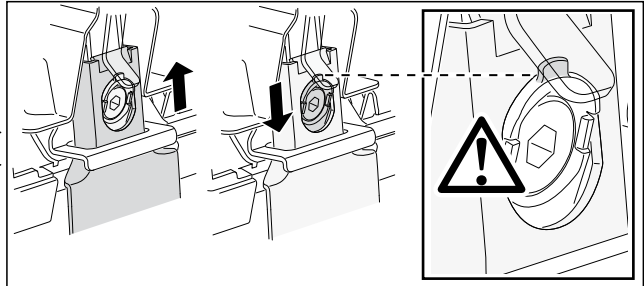
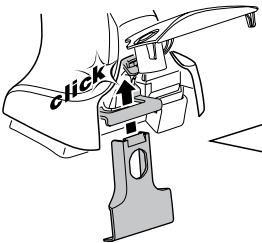
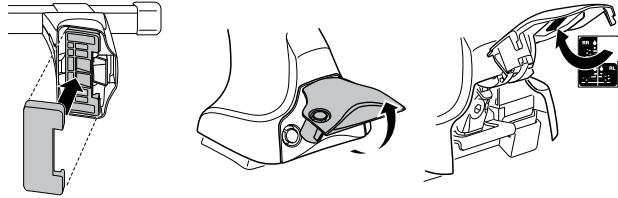
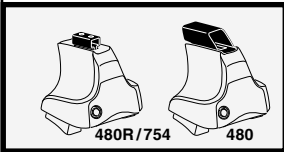
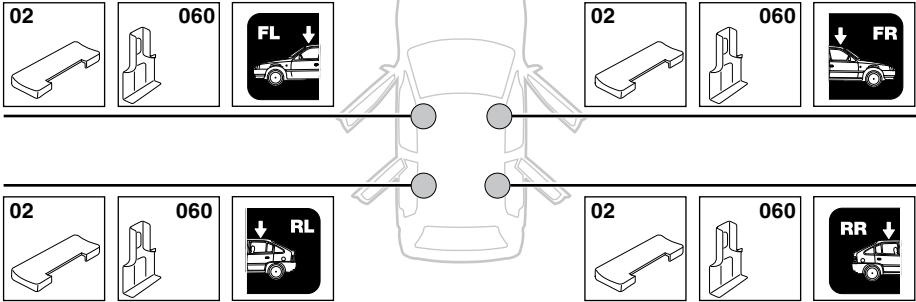

5



	X mm	Y mm	X inch	Y inch
INFINITI I30, 4-dr Sedan, *95-99	203 mm	650 mm	8"	25 ⁵ / ₈ "
NISSAN Maxima, 4-dr Sedan, 95-99	203 mm	650 mm	8"	25 ⁵ / ₈ "

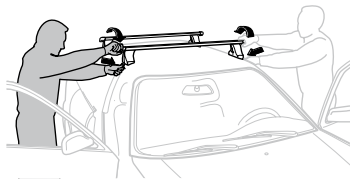
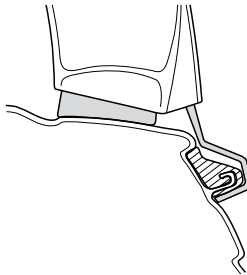
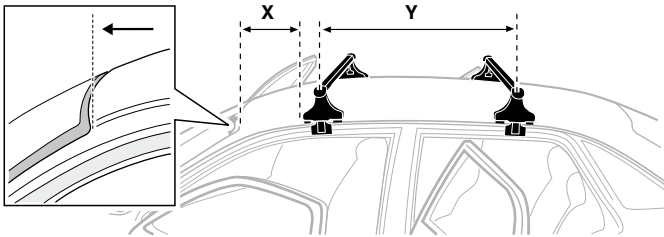

GB/US Tighten alternately

D Die Schrauben abwechselnd anziehen

F Serrer alternativement chaque côté

NL Afwisselend aan de linker- en de rechterkant aandraaien

I Alternare il serraggio delle viti

E Serrare alternativamente

PT Aperte alternadamente

S Dra åt växelvís

FIN Kierrä vuorotellen

EST Pinguldage vaheldumisi

LAT Pielvelciet pamāšus

LIT Užsukinėkite pakaitomis

PL Śruby dokręcaj naprzemiennie

RU Затягивайте попеременно

CZ Pokręťta bagażníka dokręcaj dokręcaj naprzemiennie.

SK Doťahujte striedavo

SLO Privijajte izmenično.

HR Naizmjenično zategnite

HU Egymástól függetlenül szorítandó

GR Σφίγγετε εναλλάξ

TR Dönüşümlü sıkın

中文 交替拧紧

한국어 번갈아 가며 조이십시오.

日本語 交互に締め付けてください。

ไทย ชั้โน้แบบสลับ

6



480R/754



480

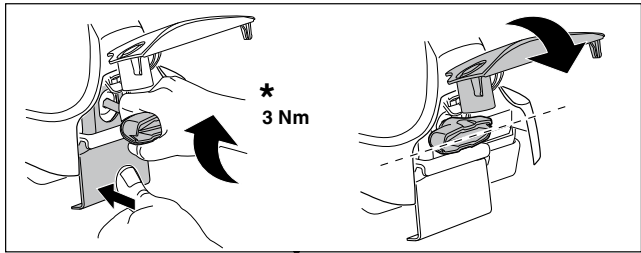

*
3 Nm



*



*
≈ 3 Nm

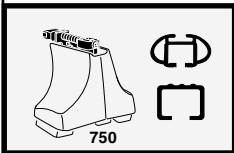

750

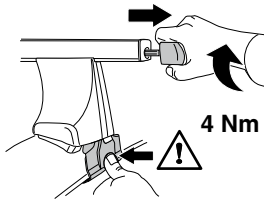

4 Nm

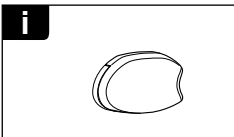
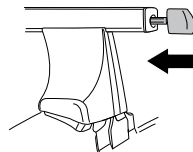

i

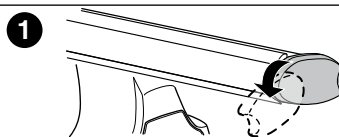

1

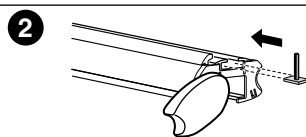

2

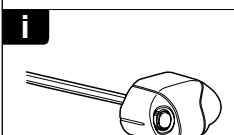

i

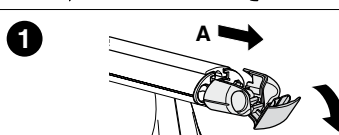

1

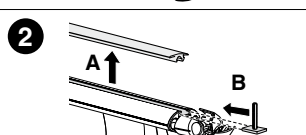

2

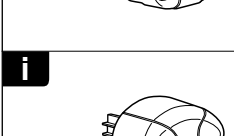

i

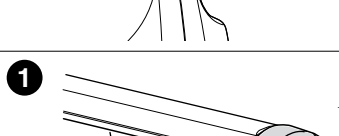

1

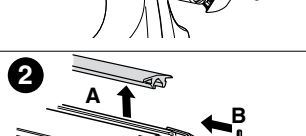

2



THULE
SWEDEN
**ONE
KEY
SYSTEM**



		(x4)
544		(x6)
596		(x8)
588		(x10)
NA 510		(x12)
EUR		
ASIA		



WW ▶ Thule Sweden AB, Box 69, 330 33 Hillerstorp, SWEDEN
NA ▶ Thule Inc., 42 Silvermine Road, Seymour, Connecticut 06483, USA

info@thule.com
customer.service@thule.com

www.thule.com