

# Kit 1292

- FORD Ranger**, 2-dr Single Cab, 98-02, 03-11
  - FORD Ranger**, 2-dr Super Cab, \*98-11
  - FORD Ranger**, 4-dr Double Cab, 98-02, 03-11
  - FORD Ranger**, 4-dr Super Cab, 98-02, 03-11
  - MAZDA B-Series**, 2-dr Single Cab, 98-06
  - MAZDA B-Series**, 3-dr Extended Cab, \*98-06
  - MAZDA B-Series**, 4-dr Double Cab, 98-06
  - MAZDA B-Series**, 4-dr Extended Cab, \*98-06
  - MAZDA BT-50**, 2-dr Single Cab, 07-11
  - MAZDA BT-50**, 4-dr Crew Cab, 07-11
  - MAZDA BT-50**, 4-dr Double Cab, 07-11
  - MAZDA Freestyle**, 4-dr Maxi Cab, 03-11
- \*North America

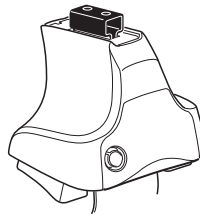

**754** Rapid System  
**480R** Rapid Traverse (North America)

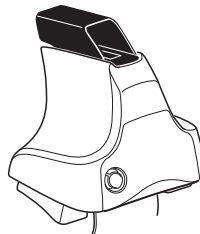
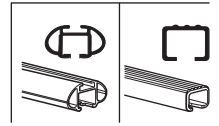

**480** Traverse (North America)

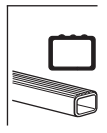

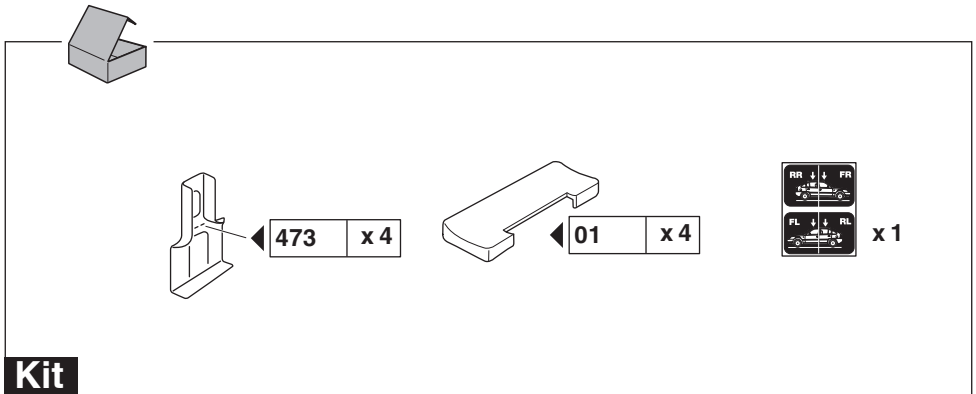
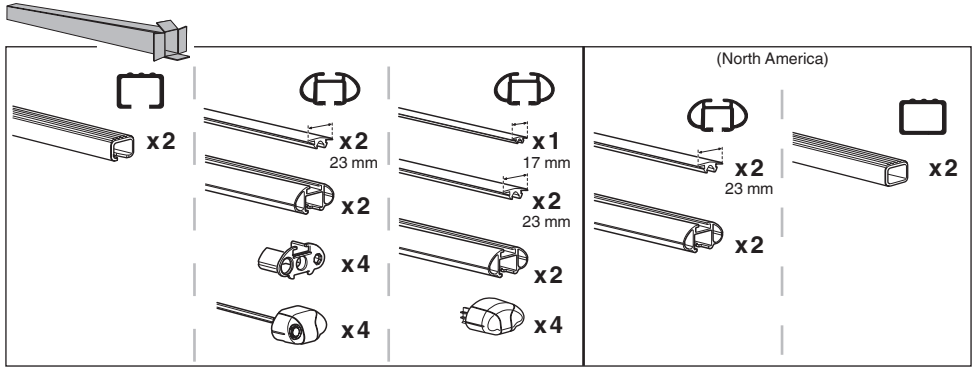
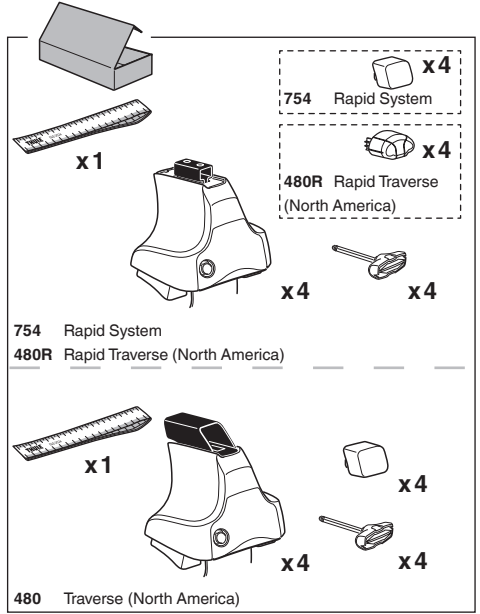
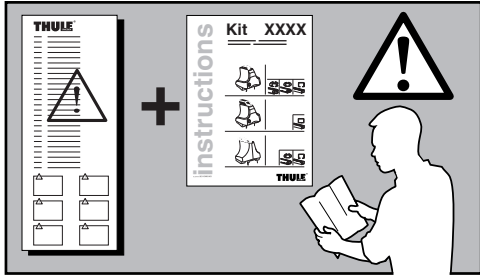
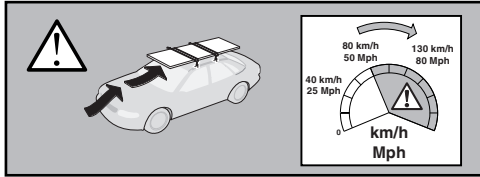
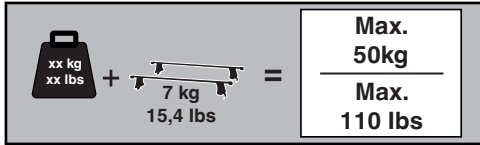

**Kit**

1

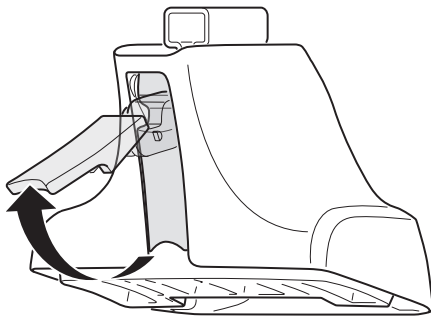

2



754 Rapid System  
480R Rapid Traverse  
(North America)

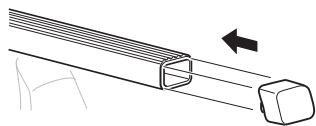
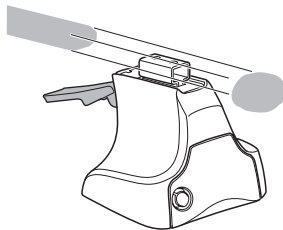

x4

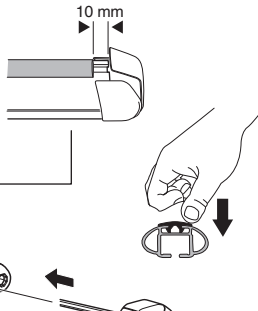

x4

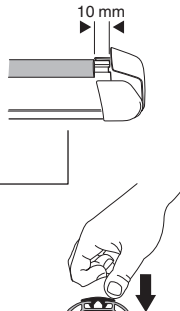

x4



480 Traverse  
(North America)

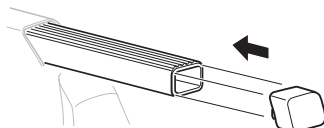
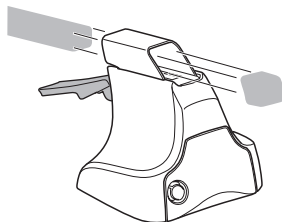

x4

3

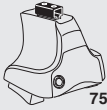

754 Rapid System

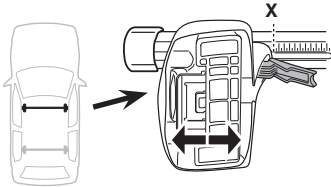

X

<b>FORD Ranger</b> , 2-dr Single Cab, 98-02, 03-11	<b>33</b>
<b>FORD Ranger</b> , 2-dr Super Cab, *98-11	<b>33</b>
<b>FORD Ranger</b> , 4-dr Double Cab, 98-02, 03-11	<b>32,5</b>
<b>FORD Ranger</b> , 4-dr Super Cab, 98-02, 03-11	<b>32,5</b>
<b>MAZDA B-series</b> , 2-dr Single Cab, 98-06	<b>33</b>
<b>MAZDA B-series</b> , 3-dr Extended Cab, *98-06	<b>33</b>
<b>MAZDA B-series</b> , 4-dr Double Cab, 98-06	<b>32,5</b>
<b>MAZDA B-series</b> , 4-dr Extended Cab, *98-06	<b>32,5</b>
<b>MAZDA BT-50</b> , 2-dr Single Cab, 07-11	<b>33,5</b>
<b>MAZDA BT-50</b> , 4-dr Crew Cab, 07-11	<b>33,5</b>
<b>MAZDA BT-50</b> , 4-dr Double Cab, 07-11	<b>33,5</b>
<b>MAZDA Freestyle</b> , 4-dr Maxi Cab, 03-11	<b>32,5</b>

Y

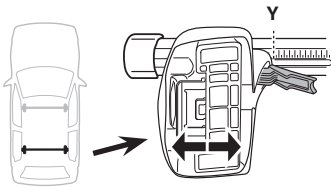

<b>FORD Ranger</b> , 2-dr Single Cab, 98-02, 03-11	-
<b>FORD Ranger</b> , 2-dr Super Cab, *98-11	-
<b>FORD Ranger</b> , 4-dr Double Cab, 98-02, 03-11	<b>32,5</b>
<b>FORD Ranger</b> , 4-dr Super Cab, 98-02, 03-11	<b>32,5</b>
<b>MAZDA B-series</b> , 2-dr Single Cab, 98-06	-
<b>MAZDA B-series</b> , 3-dr Extended Cab, *98-06	-
<b>MAZDA B-series</b> , 4-dr Double Cab, 98-06	<b>32,5</b>
<b>MAZDA B-series</b> , 4-dr Extended Cab, *98-06	<b>32,5</b>
<b>MAZDA BT-50</b> , 2-dr Single Cab, 07-11	-
<b>MAZDA BT-50</b> , 4-dr Crew Cab, 07-11	<b>32,5</b>
<b>MAZDA BT-50</b> , 4-dr Double Cab, 07-11	<b>32,5</b>
<b>MAZDA Freestyle</b> , 4-dr Maxi Cab, 03-11	<b>32,5</b>

4

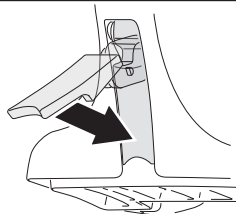

**3**



**480R** Rapid Traverse



**480** Traverse



**(North America)**

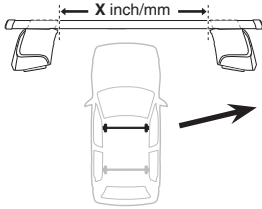

	X inch	X mm
<b>FORD Ranger</b> , 2-dr Single Cab, 98-02, 03-11	<b>38 5/8"</b>	<b>981 mm</b>
<b>FORD Ranger</b> , 2-dr Super Cab, *98-11	<b>38 5/8"</b>	<b>981 mm</b>
<b>FORD Ranger</b> , 4-dr Double Cab, 98-02, 03-11	<b>38 3/8"</b>	<b>976 mm</b>
<b>FORD Ranger</b> , 4-dr Super Cab, 98-02, 03-11	<b>38 3/8"</b>	<b>976 mm</b>
<b>MAZDA B-series</b> , 2-dr Single Cab, 98-06	<b>38 5/8"</b>	<b>981 mm</b>
<b>MAZDA B-series</b> , 3-dr Extended Cab, *98-06	<b>38 5/8"</b>	<b>981 mm</b>
<b>MAZDA B-series</b> , 4-dr Double Cab, 98-06	<b>38 7/8"</b>	<b>986 mm</b>
<b>MAZDA B-series</b> , 4-dr Extended Cab, *98-06	<b>38 7/8"</b>	<b>986 mm</b>
<b>MAZDA BT-50</b> , 2-dr Single Cab, 07-11	<b>38 7/8"</b>	<b>986 mm</b>
<b>MAZDA BT-50</b> , 4-dr Crew Cab, 07-11	<b>38 7/8"</b>	<b>986 mm</b>
<b>MAZDA BT-50</b> , 4-dr Double Cab, 07-11	<b>38 7/8"</b>	<b>986 mm</b>
<b>MAZDA Freestyle</b> , 4-dr Maxi Cab, 03-11	<b>38 3/8"</b>	<b>976 mm</b>

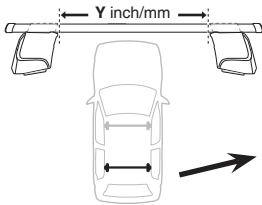

	Y inch	Y mm
<b>FORD Ranger</b> , 2-dr Single Cab, 98-02, 03-11	-	-
<b>FORD Ranger</b> , 2-dr Super Cab, *98-11	-	-
<b>FORD Ranger</b> , 4-dr Double Cab, 98-02, 03-11	<b>38 3/8"</b>	<b>976 mm</b>
<b>FORD Ranger</b> , 4-dr Super Cab, 98-02, 03-11	<b>38 3/8"</b>	<b>976 mm</b>
<b>MAZDA B-series</b> , 2-dr Single Cab, 98-06	-	-
<b>MAZDA B-series</b> , 3-dr Extended Cab, *98-06	-	-
<b>MAZDA B-series</b> , 4-dr Double Cab, 98-06	<b>38 3/8"</b>	<b>976 mm</b>
<b>MAZDA B-series</b> , 4-dr Extended Cab, *98-06	<b>38 3/8"</b>	<b>976 mm</b>
<b>MAZDA BT-50</b> , 2-dr Single Cab, 07-11	-	-
<b>MAZDA BT-50</b> , 4-dr Crew Cab, 07-11	<b>38 3/8"</b>	<b>976 mm</b>
<b>MAZDA BT-50</b> , 4-dr Double Cab, 07-11	<b>38 3/8"</b>	<b>976 mm</b>
<b>MAZDA Freestyle</b> , 4-dr Maxi Cab, 03-11	<b>38 3/8"</b>	<b>976 mm</b>

**4**

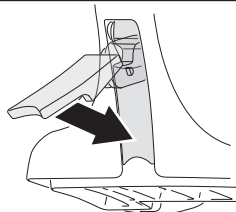

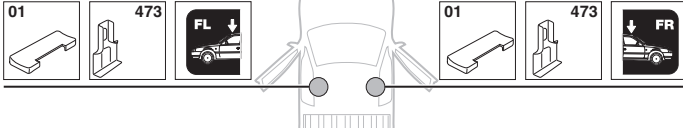
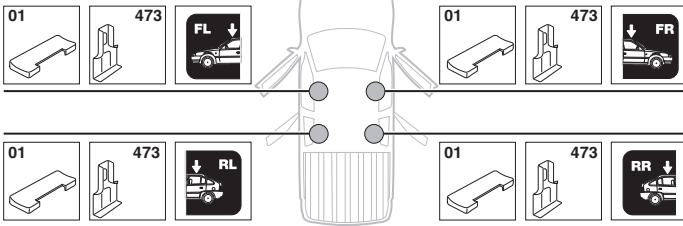
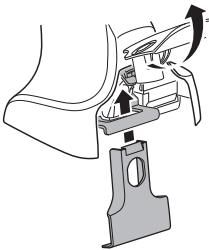
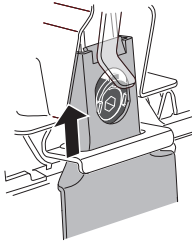
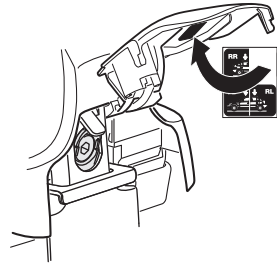
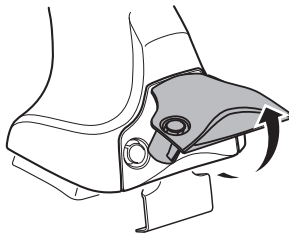
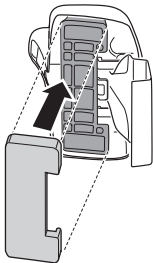
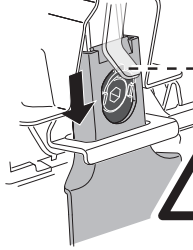
**5****FORD Ranger, 2-dr Single Cab, 98-02, 03-11****FORD Ranger, 2-dr Super Cab, \*98-11****MAZDA B-series, 2-dr Single Cab, 98-06****MAZDA B-series, 3-dr Extended Cab, \*98-06****MAZDA BT-50, 2-dr Single Cab, 07-11****FORD Ranger, 4-dr Double Cab, 98-02, 03-11****FORD Ranger, 4-dr Super Cab, 98-02, 03-11****MAZDA B-series, 4-dr Double Cab, 98-06****MAZDA B-series, 4-dr Extended Cab, \*98-06****MAZDA BT-50, 4-dr Crew Cab, 07-11****MAZDA BT-50, 4-dr Double Cab, 07-11****MAZDA Freestyle, 4-dr Maxi Cab, 03-11****A****B****C**

6

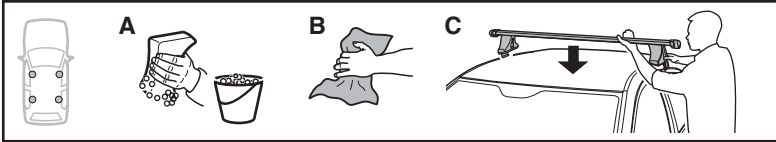

	X mm	Y mm	X inch	Y inch
<b>FORD Ranger, 2-dr Single Cab, 98-02, 03-11</b>	320 mm	-	12 <sup>5</sup> / <sub>8</sub> "	-
<b>FORD Ranger, 2-dr Super Cab, *98-11</b>	320 mm	-	12 <sup>5</sup> / <sub>8</sub> "	-
<b>MAZDA B-series, 2-dr Single Cab, 98-06</b>	320 mm	-	12 <sup>5</sup> / <sub>8</sub> "	-
<b>MAZDA B-series, 3-dr Extended Cab, *98-06</b>	320 mm	-	12 <sup>5</sup> / <sub>8</sub> "	-
<b>MAZDA BT-50, 2-dr Single Cab, 07-11</b>	320 mm	-	12 <sup>5</sup> / <sub>8</sub> "	-

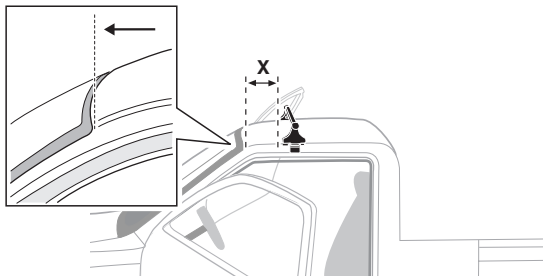

	X mm	Y mm	X inch	Y inch
<b>FORD Ranger, 4-dr Double Cab, 98-02, 03-11</b>	320 mm	750 mm	12 <sup>5</sup> / <sub>8</sub> "	29 <sup>1</sup> / <sub>2</sub> "
<b>FORD Ranger, 4-dr Super Cab, 98-02, 03-11</b>	320 mm	750 mm	12 <sup>5</sup> / <sub>8</sub> "	29 <sup>1</sup> / <sub>2</sub> "
<b>MAZDA B-series, 4-dr Double Cab, 98-06</b>	320 mm	750 mm	12 <sup>5</sup> / <sub>8</sub> "	29 <sup>1</sup> / <sub>2</sub> "
<b>MAZDA B-series, 4-dr Extended Cab, *98-06</b>	320 mm	750 mm	12 <sup>5</sup> / <sub>8</sub> "	29 <sup>1</sup> / <sub>2</sub> "
<b>MAZDA BT-50, 4-dr Crew Cab, 07-11</b>	320 mm	750 mm	12 <sup>5</sup> / <sub>8</sub> "	29 <sup>1</sup> / <sub>2</sub> "
<b>MAZDA BT-50, 4-dr Double Cab, 07-11</b>	320 mm	750 mm	12 <sup>5</sup> / <sub>8</sub> "	29 <sup>1</sup> / <sub>2</sub> "
<b>MAZDA Freestyle, 4-dr Maxi Cab, 03-11</b>	320 mm	750 mm	12 <sup>5</sup> / <sub>8</sub> "	29 <sup>1</sup> / <sub>2</sub> "

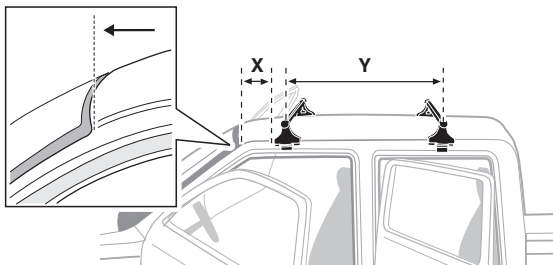

7

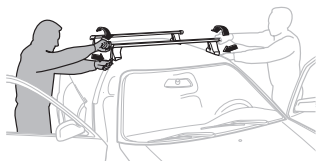
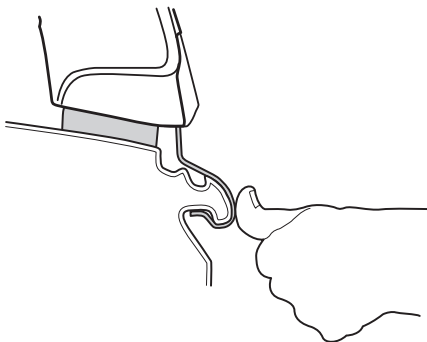

- GB/US** Tighten alternately  
**D** Die Schrauben abwechselnd anziehen  
**F** Serrer alternativement chaque côté  
**NL** Afwisselend aan de linker- en de rechterkant aandraaien  
**I** Alternare il serraggio delle viti  
**E** Apretar alternativamente  
**PT** Aperte alternadamente  
**S** Dra åt växelvis  
**FIN** Kierrä vuorotellen  
**EST** Pinguldage vaheldumisi  
**LAT** Pievelciēt pamišus  
**LIT** Užsukinėkite pakaitomis  
**PL** Śruby dokręcaj naprzemiennie  
**RU** Затягивайте попеременно

- CZ** Pokrétla багаžnika dokręcaj dokręcaj naprzemiennie.  
**SK** Dofahujte striedavo  
**SLO** Privijajte izmenično.  
**HR** Naizmjenično zategnite  
**HU** Egymástól függetlenül szorítandó

- GR** Σφιγγετε εναλλάξ  
**TR** Dönüşümlü sıkın

**中文** 交替拧紧

**한국어** 번갈아 가며 조이십시오.

**日本語** 交互に締め付けてください。

**ไทย** ขึ้นในแบบสลับ

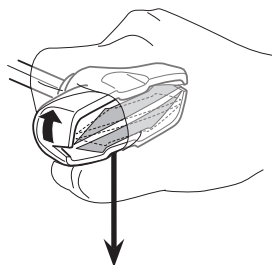
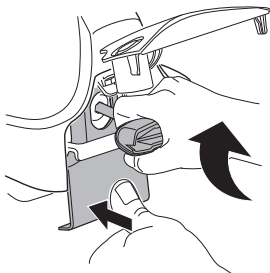
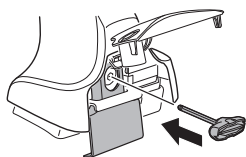

≈ 3 Nm

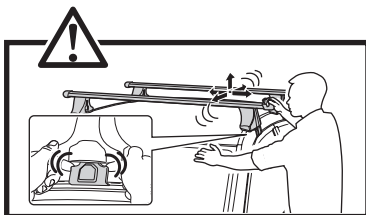
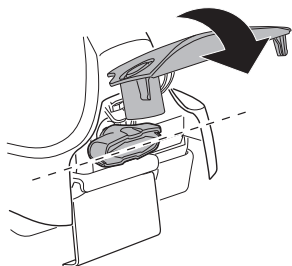
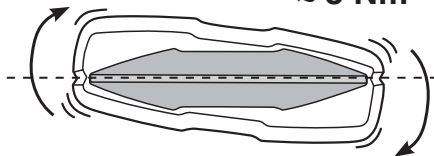



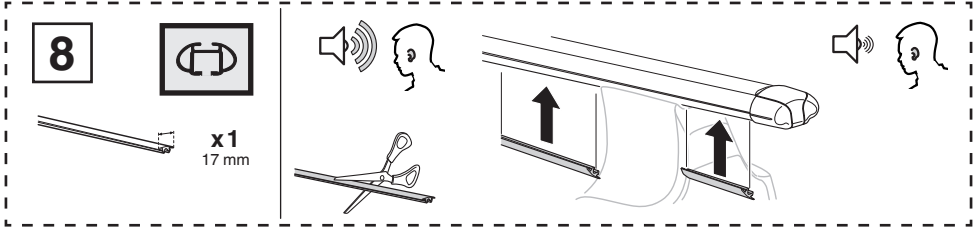

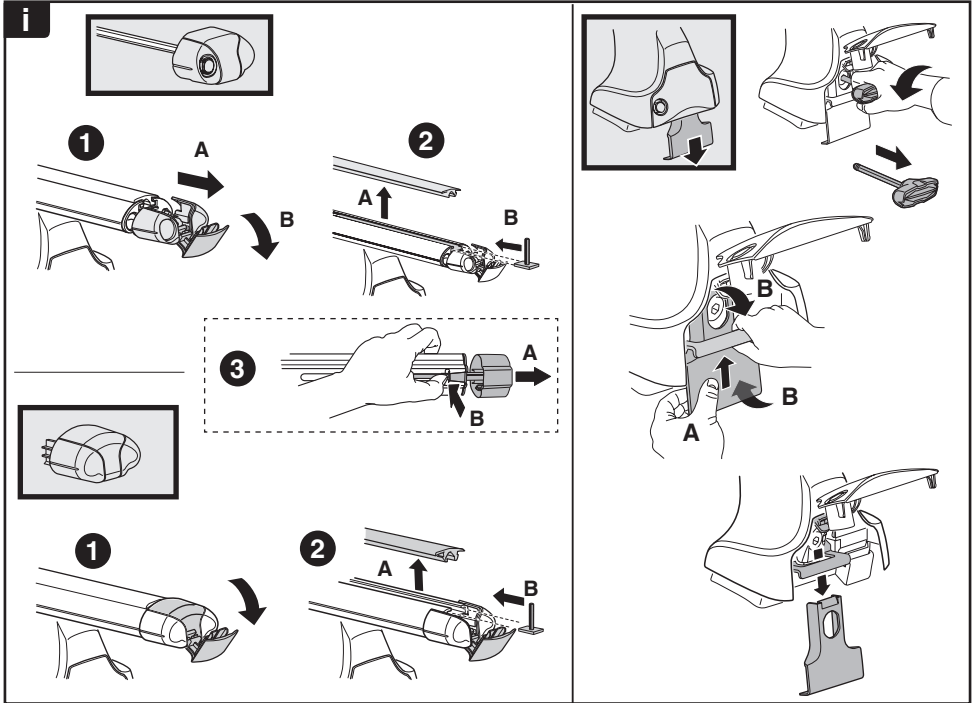
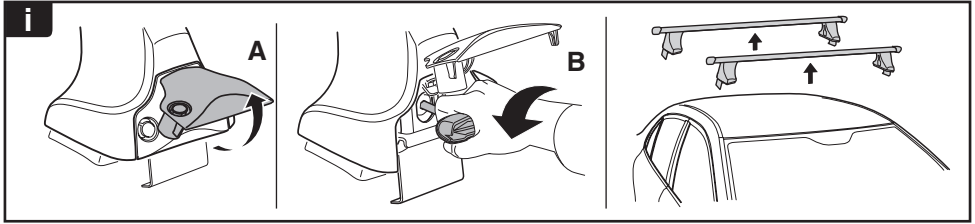

**THULE**  
SWEDEN  
**ONE  
KEY  
SYSTEM**

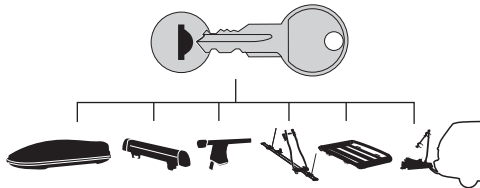

**544** (x4)

**596** (x6)

**588** (x8)

NA **510** (x10)

EUR **452** (x12)

ASIA

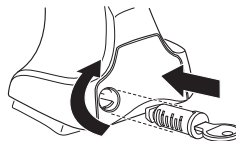

WW ▶ Thule Sweden AB, Box 69, 330 33 Hillerstorp, SWEDEN  
NA ▶ Thule Inc., 42 Silvermine Road, Seymour, Connecticut 06483, USA

info@thule.com  
customer.service@thule.com

 www.thule.com





www.thuleprofessional.com



customer.service@thule.com

info@thule.com



Thule Inc., 42 Silvermine Road, Seymour, Connecticut 06483, USA  
Thule Sweden AB, Box 69, 330 33 Hillerstorp, SWEDEN

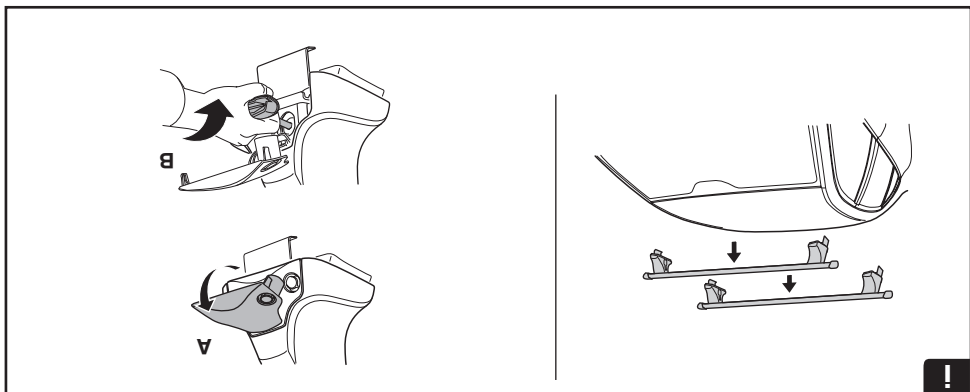
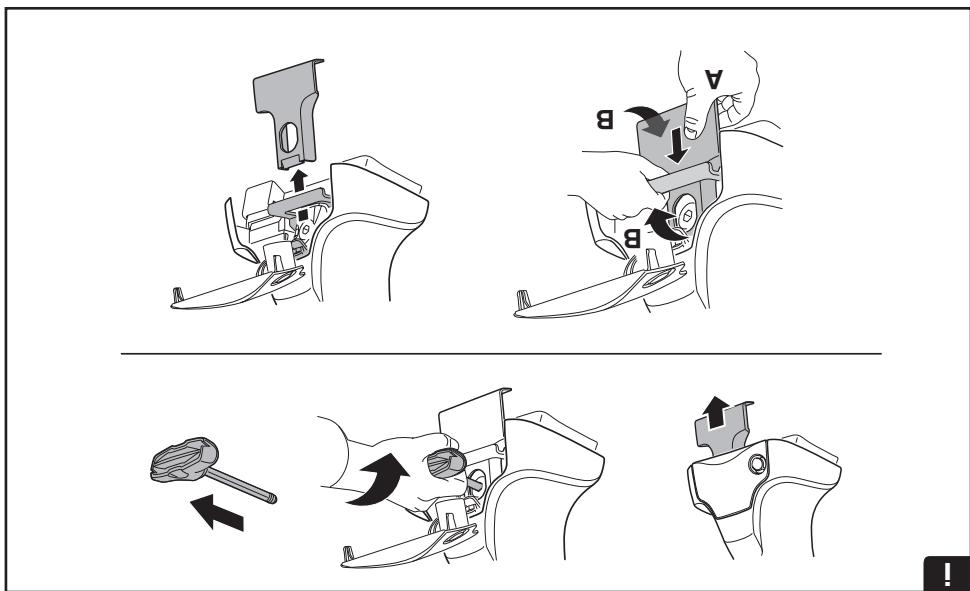

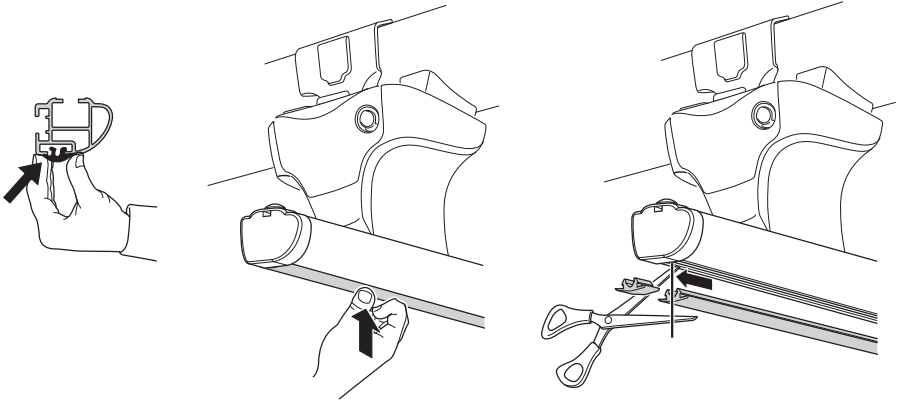

x2 25mm

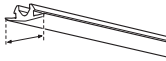

9

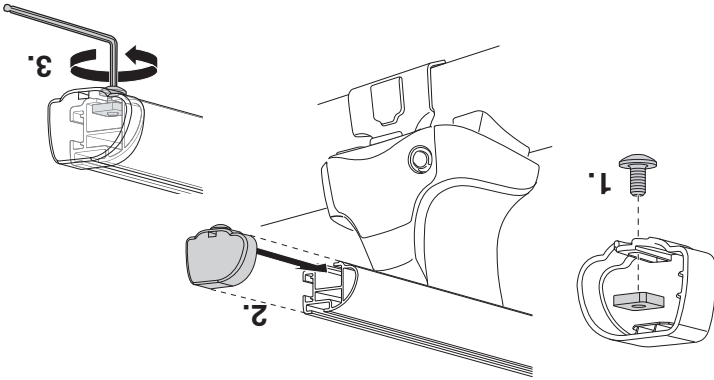

x1 5mm



x4



x4



x2



x2

8

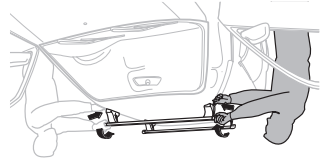
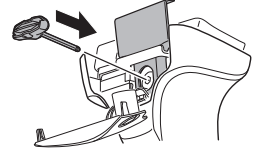
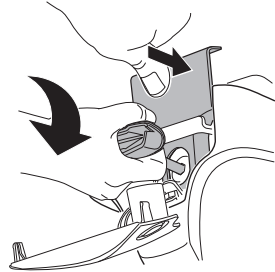
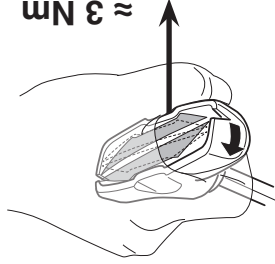
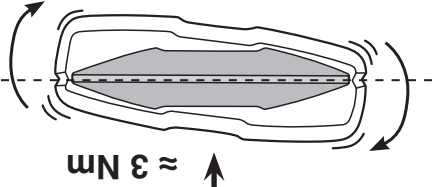
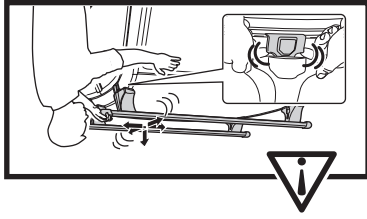
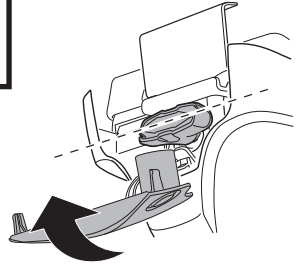

**CZ** Pokrečia bagazníka dokrecaj dokrecaj naprzemennie.  
**SK** Dotahujte smeravo.  
**SLO** Privijajte izmenično.  
**HR** Naizmenično zategnite.  
**HU** Egymástól függetlenül szorítandó.  
**GR** Ζφύγστε εναλλάξ.  
**TR** Dönüştürülü sıkın.  
**中文** 交替拧紧。  
**한국어** 번갈아 가며 조이십시오.  
**日本語** 交互に締め付けてください。  
**ไทย** หมุนสลับกัน

**GB/US** Tighten alternately.  
**D** Die Schrauben abwechselnd anziehen.  
**F** Serrer alternativement chaque côté.  
**NL** Afwisselend aan de linker- en de rechterkant aandraaien.  
**I** Alternare il serraggio delle viti.  
**E** Aprelar alternativamente.  
**PT** Abra à váxelos.  
**S** Dra åt växelvis.  
**FIN** Kierrä vuorotellen.  
**EST** Pinguldage vaheldumisi.  
**LAT** Pivēciēti pamēbus.  
**LIT** Užukinėkite pakaitomis.  
**PL** Śruby dokrecaj naprzemennie.  
**RU** Затягивайте попеременно.

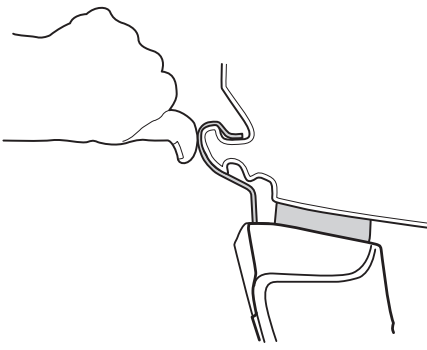

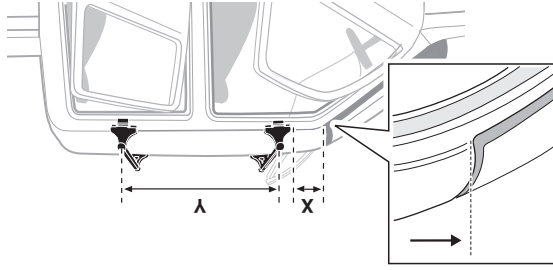

				FORD Ranger, 4-dr Double Cab, 98-02, 03-11
320 mm	750 mm	320 mm	750 mm	FORD Ranger, 4-dr Super Cab, 98-02, 03-11
320 mm	750 mm	320 mm	750 mm	MAZDA B-series, 4-dr Double Cab, 98-06
320 mm	750 mm	320 mm	750 mm	MAZDA B-series, 4-dr Extended Cab, *98-06
320 mm	750 mm	320 mm	750 mm	MAZDA BT-50, 4-dr Crew Cab, 07-11
320 mm	750 mm	320 mm	750 mm	MAZDA BT-50, 4-dr Double Cab, 07-11
320 mm	750 mm	320 mm	750 mm	MAZDA Freestyle, 4-dr Maxi Cab, 03-11
X mm	Y mm	X inch	Y inch	

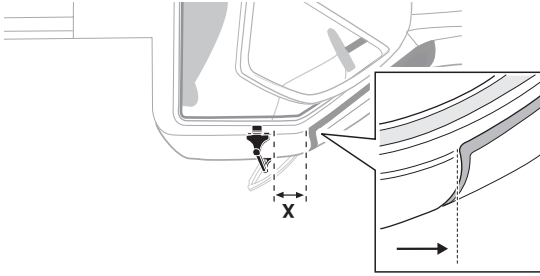

				FORD Ranger, 2-dr Single Cab, 98-02, 03-11
320 mm	-	320 mm	-	FORD Ranger, 2-dr Super Cab, *98-11
320 mm	-	320 mm	-	MAZDA B-series, 2-dr Single Cab, 98-06
320 mm	-	320 mm	-	MAZDA B-series, 3-dr Extended Cab, *98-06
320 mm	-	320 mm	-	MAZDA BT-50, 2-dr Single Cab, 07-11
X mm	Y mm	X inch	Y inch	

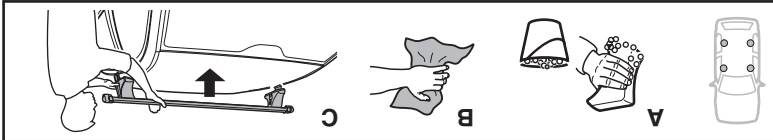

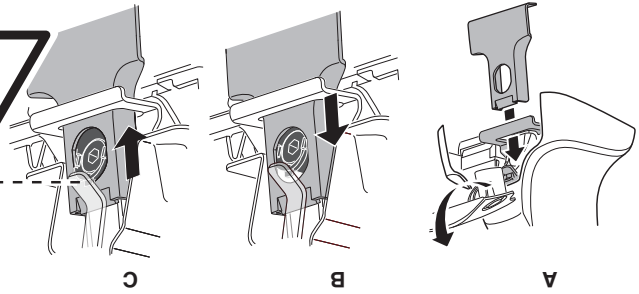
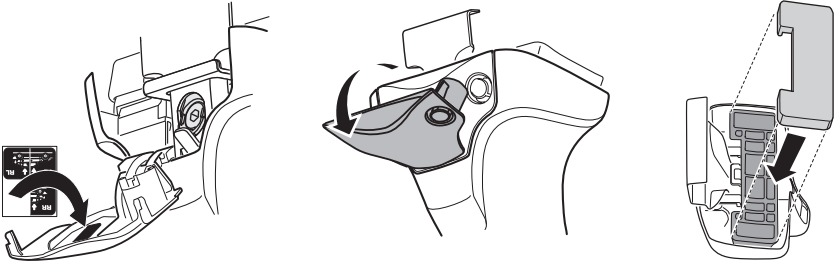

- FORD Ranger**, 4-dr Double Cab, 98-02, 03-11
- FORD Ranger**, 4-dr Super Cab, 98-02, 03-11
- MAZDA B-series**, 4-dr Double Cab, 98-06
- MAZDA B-series**, 4-dr Extended Cab, '98-06
- MAZDA BT-50**, 4-dr Crew Cab, 07-11
- MAZDA BT-50**, 4-dr Double Cab, 07-11
- MAZDA Freestyle**, 4-dr Maxi Cab, 03-11

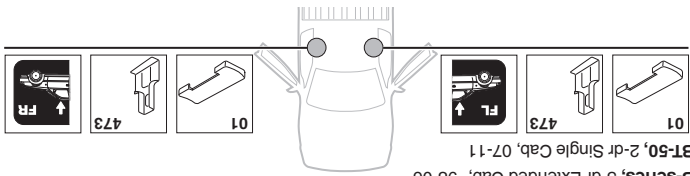

- FORD Ranger**, 2-dr Single Cab, 98-02, 03-11
- MAZDA B-series**, 2-dr Single Cab, 98-06
- MAZDA B-series**, 3-dr Extended Cab, '98-06
- MAZDA BT-50**, 2-dr Single Cab, 07-11



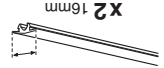
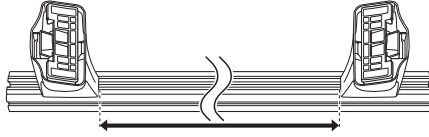
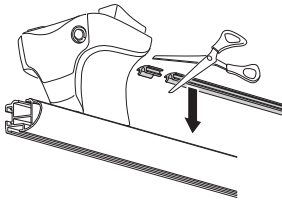

4

FORD Ranger, 2-dr Single Cab, 98-02, 03-11	-	-
FORD Ranger, 2-dr Super Cab, *98-11	-	-
FORD Ranger, 4-dr Double Cab, 98-02, 03-11	38 3/8"	976 mm
FORD Ranger, 4-dr Super Cab, 98-02, 03-11	38 3/8"	976 mm
MAZDA B-series, 2-dr Single Cab, 98-06	-	-
MAZDA B-series, 3-dr Extended Cab, *98-06	-	-
MAZDA B-series, 4-dr Double Cab, 98-06	38 3/8"	976 mm
MAZDA B-series, 4-dr Extended Cab, *98-06	38 3/8"	976 mm
MAZDA BT-50, 2-dr Single Cab, 07-11	-	-
MAZDA BT-50, 4-dr Crew Cab, 07-11	38 3/8"	976 mm
MAZDA BT-50, 4-dr Double Cab, 07-11	38 3/8"	976 mm
MAZDA Freestyle, 4-dr Maxi Cab, 03-11	38 3/8"	976 mm

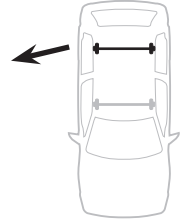
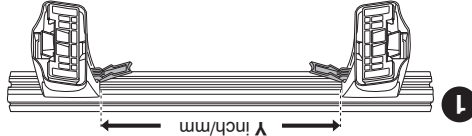
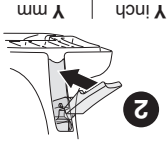

FORD Ranger, 2-dr Single Cab, 98-02, 03-11	38 3/8"	981 mm
FORD Ranger, 2-dr Super Cab, *98-11	38 3/8"	981 mm
FORD Ranger, 4-dr Double Cab, 98-02, 03-11	38 3/8"	976 mm
FORD Ranger, 4-dr Super Cab, 98-02, 03-11	38 3/8"	976 mm
MAZDA B-series, 2-dr Single Cab, 98-06	38 3/8"	981 mm
MAZDA B-series, 3-dr Extended Cab, *98-06	38 3/8"	981 mm
MAZDA B-series, 4-dr Double Cab, 98-06	38 7/8"	986 mm
MAZDA B-series, 4-dr Extended Cab, *98-06	38 7/8"	986 mm
MAZDA BT-50, 2-dr Single Cab, 07-11	38 7/8"	986 mm
MAZDA BT-50, 4-dr Crew Cab, 07-11	38 7/8"	986 mm
MAZDA BT-50, 4-dr Double Cab, 07-11	38 7/8"	986 mm
MAZDA Freestyle, 4-dr Maxi Cab, 03-11	38 3/8"	976 mm

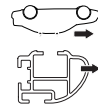
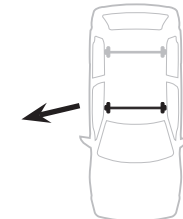
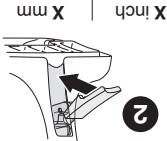

3

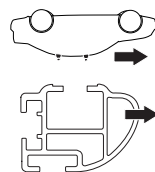
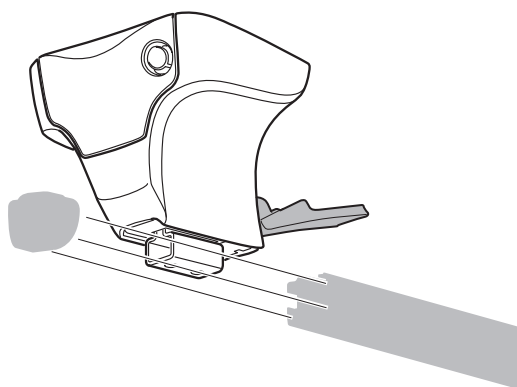
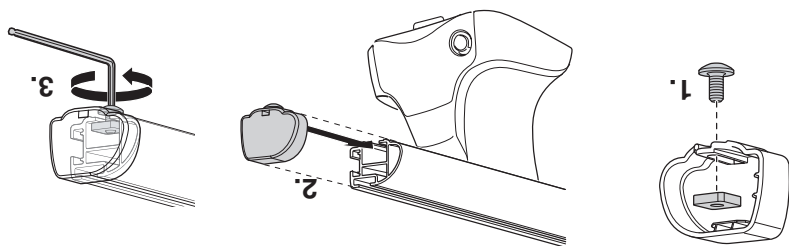

2

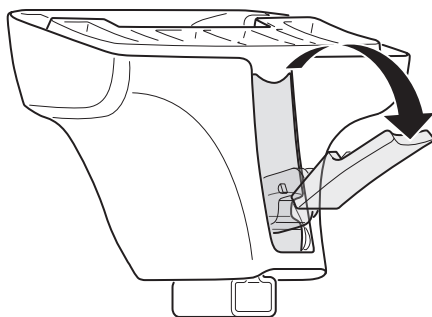

1

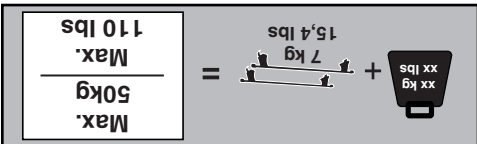
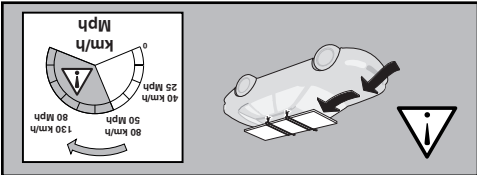
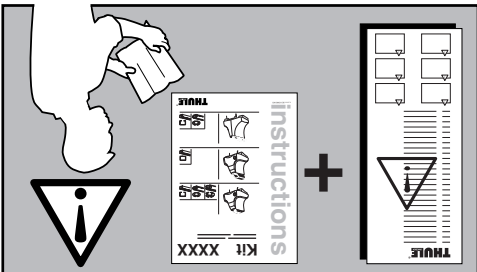
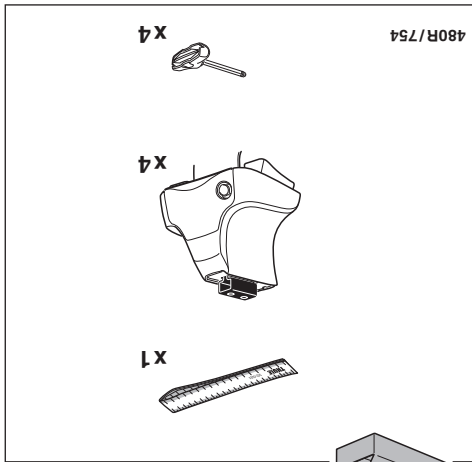
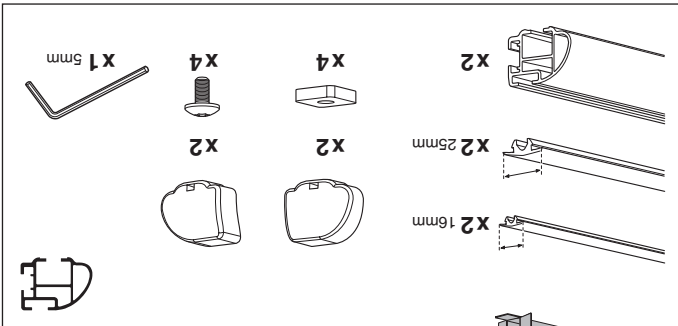
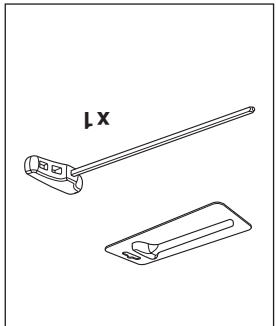
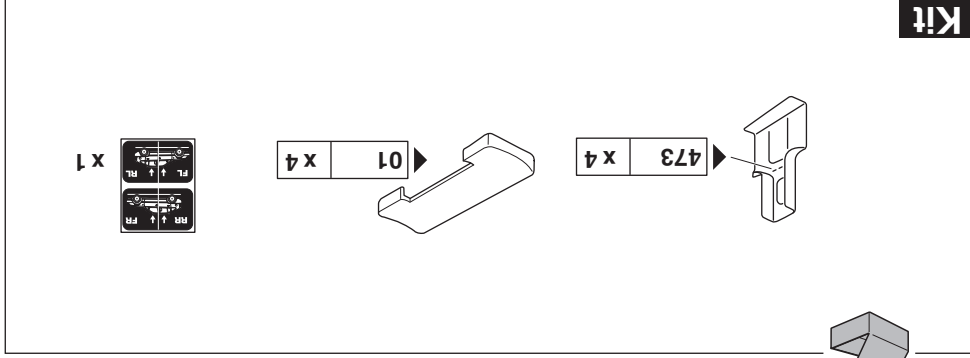

# instructions

# Kit 1292

- FORD Ranger, 2-dr Single Cab, 98-02, 03-11
- FORD Ranger, 2-dr Super Cab, \*98-11
- FORD Ranger, 4-dr Double Cab, 98-02, 03-11
- FORD Ranger, 4-dr Super Cab, 98-02, 03-11
- MAZDA B-series, 2-dr Single Cab, 98-06
- MAZDA B-series, 3-dr Extended Cab, \*98-06
- MAZDA B-series, 4-dr Double Cab, 98-06
- MAZDA B-series, 4-dr Extended Cab, \*98-06
- MAZDA BT-50, 2-dr Single Cab, 07-11
- MAZDA BT-50, 4-dr Crew Cab, 07-11
- MAZDA BT-50, 4-dr Double Cab, 07-11
- MAZDA Freestyle, 4-dr Maxi Cab, 03-11

\*North America

480R  
754

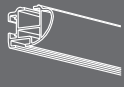
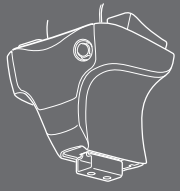

ISO 11154-E

PROFESSIONAL  
**THULE**  
SWEDEN®