

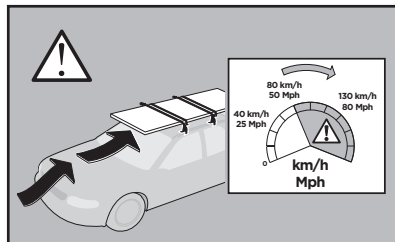

# Thule Rapid System Kit 1851

# > Instructions

PORSCHE Panamera, 5-dr Hatchback, 17-

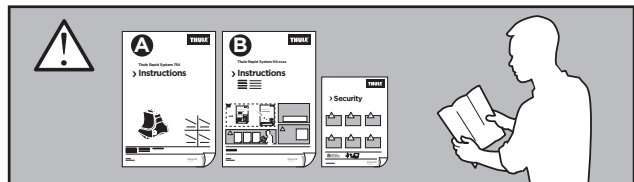
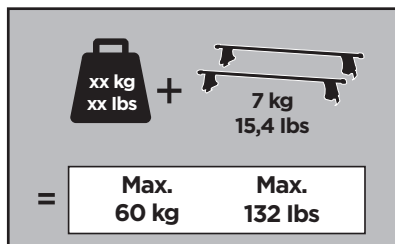
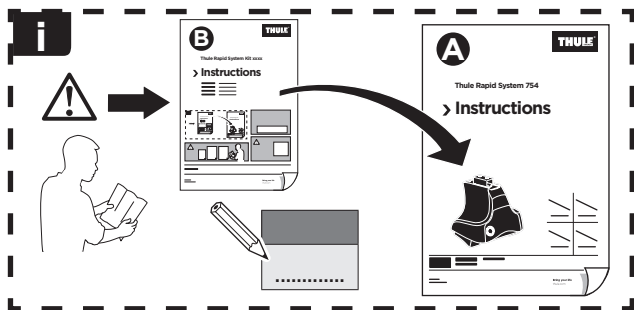

ISO 11154-E

141851  
C.20170201  
519-1851-01

Bring your life  
thule.com



138 x2

191 x1

192 x1

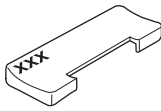

1407 x1

1408 x1

1411 x2



x1



x1

1

	X (scale)	X (mm)	X (inch)
Porsche Panamera, 5-dr Hatchback, 17-	43,5	1086	42 <sup>3</sup> / <sub>4</sub>

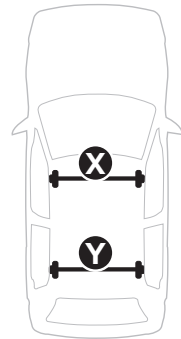
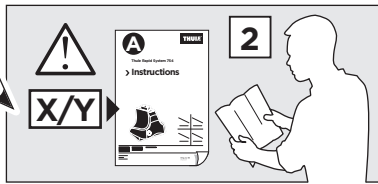
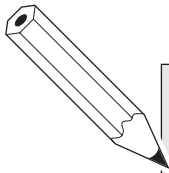

	Y (scale)	Y (mm)	Y (inch)
Porsche Panamera, 5-dr Hatchback, 17-	35	1001	39 <sup>3</sup> / <sub>8</sub>

**2**

**Porsche Panamera, 5-dr Hatchback, 17-**

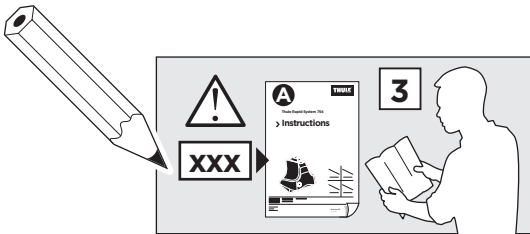
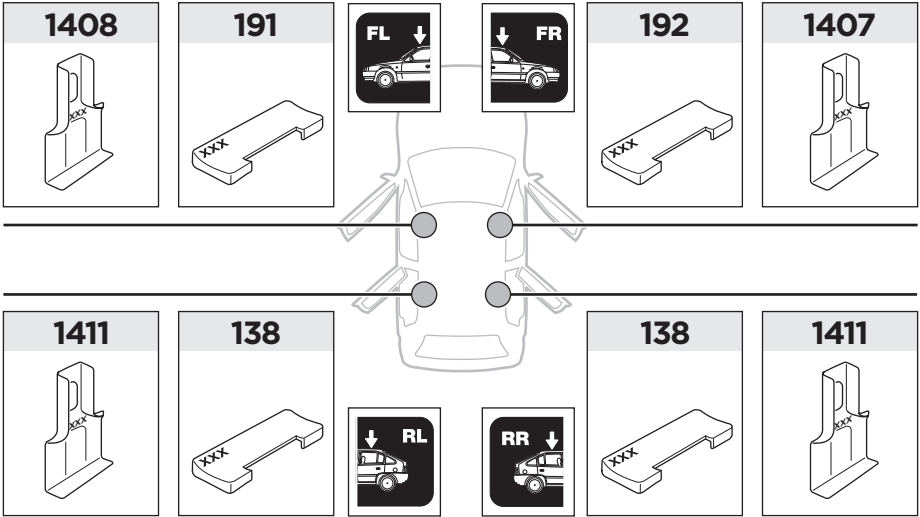

3

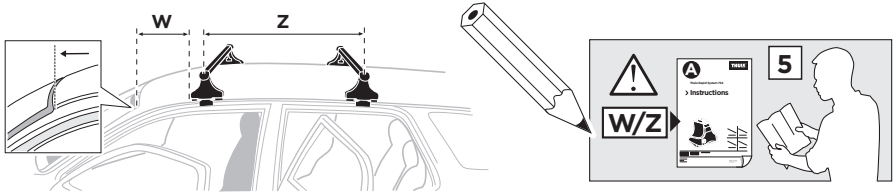

	W (mm)	Z (mm)	W (inch)	Z (inch)
<b>Porsche Panamera, 5-dr Hatchback, 17-</b>	<b>185</b>	<b>755</b>	<b>7 1/4</b>	<b>29 3/4</b>

